Table of Content

1. SiS6326 Overview.....	1
1.1 Introduction.....	1
1.2 Features.....	1
1.3 Block Diagram.....	5
1.3.1 SiS6326 System Block Diagram.....	5
1.4 “63x6V4-01x” board outline.....	6
2. Mode Tables.....	7
2.1 Standard VGA Modes.....	7
2.2 Enhanced Video Modes.....	9
2.3 Low Resolution Modes (Hidden).....	13
3. Drivers Overview.....	14
4. Windows 95.....	15
4.1 Version Note.....	15
4.2 Driver Files.....	15
4.3 Display Driver.....	15
4.3.1 Installation.....	15
4.3.2 Using "Display Modes".....	16
4.3.3 Using "SiS TV-OUT".....	16
4.3.4 Using "SiS Gamma Correction".....	17
4.4 Display Utilities.....	17
4.4.1 Installation.....	17
4.5 MPEG2 Video Playback Utility.....	18
4.5.1 Installation.....	18
4.5.2 Operation.....	18
5. Windows 3.1.....	20
5.1 Version Notes.....	20
5.2 Driver Files.....	20
5.3 Installation.....	20
5.4 SVGA Setup.....	21
5.4.1 Graphics Setup.....	21
5.4.2 Power Saving Setup.....	21
5.4.3 Zoom_Key Setup.....	21
5.4.4 Notes.....	21
5.5 Video Operations.....	22
5.5.1 DCI Function.....	22
5.5.2 SiS MMPlayer (SW MPEG).....	22
5.5.3 Notes on MMPlayer.....	22
6. Windows NT 4.0.....	24
6.1 Driver Files.....	24
6.2 Installation.....	24
6.3 Using "Display Modes".....	24
7. Windows NT 3.5 & 3.51.....	26
7.1 Driver Files.....	26

7.2 Installation.....	26
8. Autodesk ADI 4.2 -Protected Mode.....	27
8.1 General Description.....	27
8.1.1 Driver Files.....	27
8.1.2 Unpack & Copy.....	27
8.2 AutoCAD R11 Setup.....	28
8.3 AutoCAD R12 Setup.....	29
8.4 AutoShade R2.0 Setup.....	30
8.5 3D Studio Version 3.0 Setup.....	31
9. OS/2 V2.1.....	33
9.1 Driver Notes.....	33
9.2 Driver Files.....	33
9.3 Installation.....	33
10. OS/2 V3.0 (Warp).....	34
10.1 Driver & OS/2 Version Notes.....	34
10.2 Driver Files.....	34
10.3 Installation.....	34
11. Double Bytes OS/2 Warp.....	35
11.1 Driver & OS/2 Version Notes.....	35
11.2 Driver Files.....	35
11.3 Installation.....	35
12. COPYRIGHT NOTICE.....	37

1. SiS6326 Overview

1.1 Introduction

Targeting the emerging PC market, SiS6326 is the first member of the new SiS63x6 family, which consists of high integration, super performance, and feature-rich 3D/2D graphics & video accelerators.

Being a 208-pin PQFP package, SiS6326 integrates AGP/PCI VGA controller, 3D/2D graphics accelerator, NTSC/PAL TV-OUT solution, MPEG-2/1 video decoder, and video accelerator. The target of SiS6326 is to meet all the emerging PC requirements which includes 3D acceleration, output to TV, DVD/VCD player, and video acceleration in one chip and in a market acceptable price.

As the first member of 63x6 family, totally new pin-outs and application circuits are developed. However the definition of the registers are designed as backward compatible with previous SiS62x5 as possible as to shorten the product-to-market time.

1.2 Features

PCI Bus Interface

- Supports 32-bit PCI local bus standard Revision 2.1 compliant
- Supports 66MHz PCI operation
- Supports PCI bus master for 3D texture fetch
- Built-in write-once subsystem vendor ID configuration register
- Supports zero wait-state memory mapped I/O burst write
- Built-in 8 stages PCI post-write buffer to enhance frame buffer write performance
- Built-in 128 bits read cache to enhance frame buffer read performance
- Supports full 16-bit re-locatable VGA I/O address decoding
- Supports PCI multimedia design guide Rev. 1.0

AGP Interface

- Supports AGP 1.0 compliant configuration setting
- Supports AGP 133MHz

High Performance & High Quality 3D Accelerator

- **Built-in a high performance 3D engine**
 - Built-in 32-bit floating point format VLIW triangle setup engine
 - Built-in texture cache with LRU replacement strategy
 - Supports PCI master and AGP 133 MHz for texture fetch
 - Peak polygon rate: 800K polygon/sec @ 50 pixel/polygon with Gouraud shaded, point-sampled, linear and bilinear texture mapping
 - Peak fill rate: 40M pixel/sec
- **Built-in a high quality 3D engine**
 - Supports solid, flat, and Gouraud shading
 - Supports high quality dithering
 - Supports Z-test, Alpha-test, and scissors clipping test
 - Supports stipple patterns, stipple alpha, line pattern, and ROP
 - Supports Z-buffer and alpha buffer
 - Supports per-pixel texture perspective correction
 - Supports point-sampled, linear, bi-linear, and tri-linear texture filtering
 - Supports MIP structure texture
 - Supports rectangle structure texture
 - Supports 1/2/4 BPP palletize texture
 - Supports 1/2/4/8 BPP luminance texture
 - Supports 4/8 BPP mix mode texture format
 - Supports 8/16/24/32 BPP RGB/ARGB texture format
 - Supports video texture in all supported texture formats.
The supported video formats are RGB555, RGB565, and YUV422 formats

-
- Supports texture transparency, blending, wrapping, mirror, and clamping
 - Supports fogging, alpha blending, and primitive transparency

High Performance 2D Accelerator

- **Built-in 42 double-words hardware command queue**
- **Supports Turbo Queue (Software Command Queue in off-screen memory) architecture to achieve extra-high performance** (patent pending)
- **Built-in Direct Draw Accelerator**
- **Built-in an 1T 64-bit BITBLT graphics engine with the following functions:**
 - 256 raster operations
 - Rectangle fill
 - Color/Font expansion
 - Enhanced Color expansion
 - Enhanced Font expansion
 - Line-drawing with styled pattern
 - Built-in 8x16 pattern registers
 - Built-in 8x8 mask registers
 - Rectangle Clipping
 - Transparent BitBlt
 - Direct Draw
- **Supports memory-mapped, zero wait-state, burst engine write**
- **Supports burst frame buffer read/write for SDRAM/SGRAM**
- **Built-in 64x64x2 bit-mapped hardware cursor**
- **Maximum 4M Bytes frame buffer with linear addressing**
- **Built-in 4 stages engine write-buffer and 9x64 bits read-buffer to minimize engine wait-state**
- **Built-in 64x32 CRT FIFOs to support super high resolution graphics modes and reduce CPU wait-state**

Complete TV-OUT Solution

- **Built-in complete NTSC/PAL video encoder**
 - Built-in 3-Channel 10-bit DAC with power down mode
 - Built-in 3-line anti-flicker filter
 - Built-in TV sense circuits for auto detect TV connection
 - Supports RCA-style composite video and S-Video outputs
 - Supports loadable RAMDAC for gamma correction in high color and true color modes
 - No external TTL or DAC required
- **Supports NTSC/PAL interlaced display in**
 - 640x480x60Hz and 640x400x60Hz modes for NTSC
 - 640x480x50Hz and 800x600x50Hz modes for PAL
 - low resolution modes for both NTSC and PAL (hidden)
- **Supports non-interlaced scan, output either even or odd lines**
- **Supports 4 types of filtering mode: mild, medium, strong, and adaptive**
- **Supports VGA and TV simultaneous output**
- **Supports TV image positioning by hardware**
- **Supports under-scan and over-scan scaling**

MPEG-2/1 Video Decoder

- **MPEG-2 ISO/IEC 13818-2 MP@ML and MPEG-1 ISO/IEC 11172-2 standards compliant**
- **Low cost design based on MPEG macro-block layer decoding architecture**
 - Built-in run length and zig-zag decoder
 - Built-in IDCT logic
 - Built-in motion compensation logic
- **14 bits resolution in IDCT transformation**
- **Half pixel resolution in motion compensation**
- **Built-in two 196x64 video line buffers for MPEG video playback**

Video Accelerator

- **Supports single frame buffer architecture**
- **Supports YUV-to-RGB color space conversion**
- **Supports bi-linear video interpolation with integer increments of 1/64**
- **Supports graphics and video overlay function**

- Independent graphics and video formats
- 16 color-key and/or chroma-key operation
- 3-bit graphics and video blending
- Rectangular video window modes
- **Supports current scan line of refresh read-back**
- **Supports tearing free double buffer swapping**
- **Built-in video decoder interface**
 - Philips SAA7110/SAA7111
 - Brooktree BT815/817/819A (8-bit SPI mode 1,2)
- **Supports VMI to connect VMI devices**
 - Shares VMI control and data bus with MD bus
- **Supports Vertical Blank Interrupt**
- **Supports RGB555, RGB565, YUV422, and YUV420 video format**
- **Built-in 64x16 video capture FIFOs to support video capture**
- **Built-in two 196x64 video playback line buffers**
- **Supports DCI Drivers**
- **Supports Direct Draw Drivers**

Display Memory Interface

- **Supports FP, EDO, one-cycle EDO, SDRAM, and SGRAM timing**
- **Supports 1MB, 2MB, and 4MB memory configurations**
- **Supports 256Kx4, 256Kx8, and 256Kx16 FP and EDO DRAM types**
- **Supports 2-CAS/1-WE DRAM and EDO DRAM types**
- **Supports 256Kx32 SDRAM and SGRAM types up to 83.3 MHz**
- **Supports 32/64-bit display memory path**
- **Supports auto memory size detecting**

High Integration

- **Built-in programmable 24-bit true-color RAMDAC up to 175MHz pixel clock**
 - Built-in reference voltage generator and monitor sense circuit
 - Supports loadable RAMDAC for gamma correction in high color and true color modes
- **Built-in dual-clock generator**
 - Integrates PLL loop filter
- **Built-in 14.318 MHz oscillator circuits**
- **Built-in two 196x64 video line buffers for MPEG video playback**
- **Built-in standard feature connector logic support**
- **Built-in PCI multimedia interface**

Resolution, Color & Frame Rate

- **Supports 175 MHz pixel clock**
- **Supports super high resolution graphics modes**
 - 640x480 256/32K/64K/16M colors 85Hz NI
 - 800x600 16/256/32K/64K/16M colors 85Hz NI
 - 1024x768 16/256/32K/64K/16M colors 85Hz NI
 - 1280x1024 16/256/32K/64K colors 75 Hz NI
 - 1600x1200 16/256 colors 65Hz NI
 - low resolution modes (hidden)
- **Supports virtual screen up to 2048x2048**
- **Supports 80/132 columns text modes**

Power Management

- **Supports VESA Display Power Management Signaling (DPMS) compliant VGA monitor for power management**
- **Built-in 30 min. standby and suspend timers with keyboard, hardware cursor, and/or video memory read/write as activation source**
- **Supports direct I/O command to force graphics controller into standby/suspend/off state**
- **Power down internal SRAM in direct color mode**
- **Built-in a low power signal pin for supporting external power down controller**

Multimedia Application

- **Supports DDC1 and DDC2B specifications**

- **Supports RAMDAC snoop for multimedia applications**

Miscellaneous

- **Only 3 ICs (including DRAMs) required to implement a PCI true-color graphics adapter without any TTLs**
- **Supports 64K Bytes ROM decoding**
- **Supports Signature Analysis for automatic test**
- **Implemented by 3.3V CMOS technology with 5.0V tolerance I/O buffers**
- **208-pin PQFP package**

1.3 Block Diagram

1.3.1 SiS6326 System Block Diagram

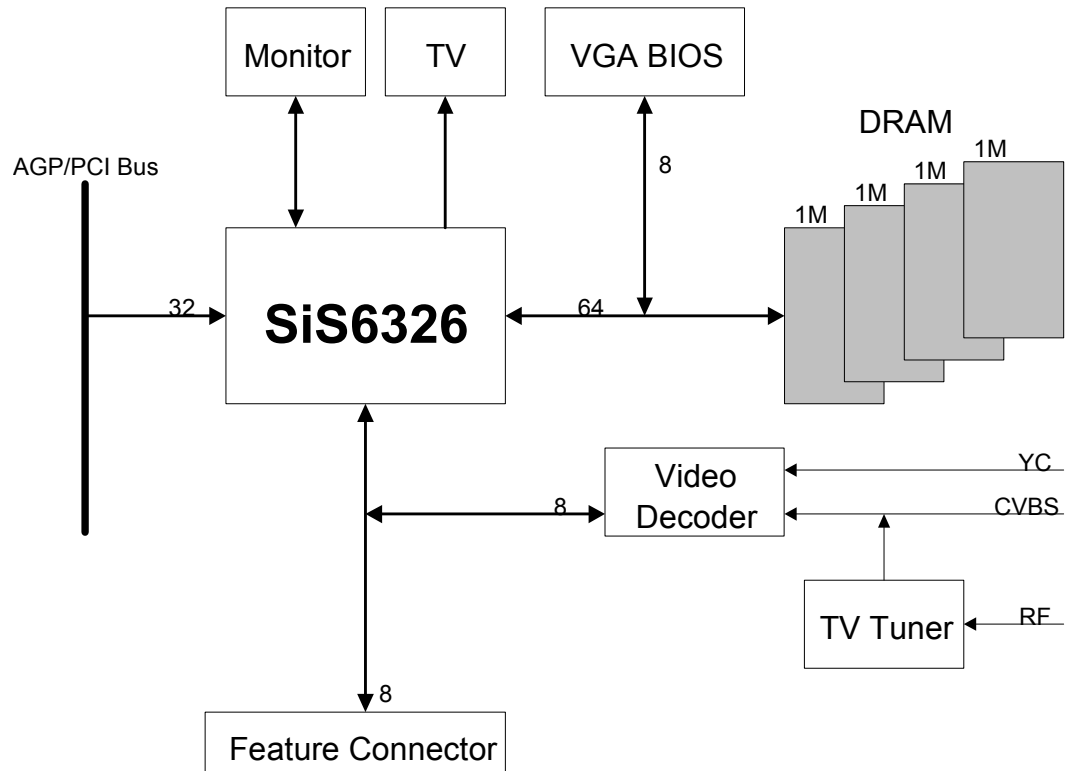

1.4 “63x6V4-01x” board outline

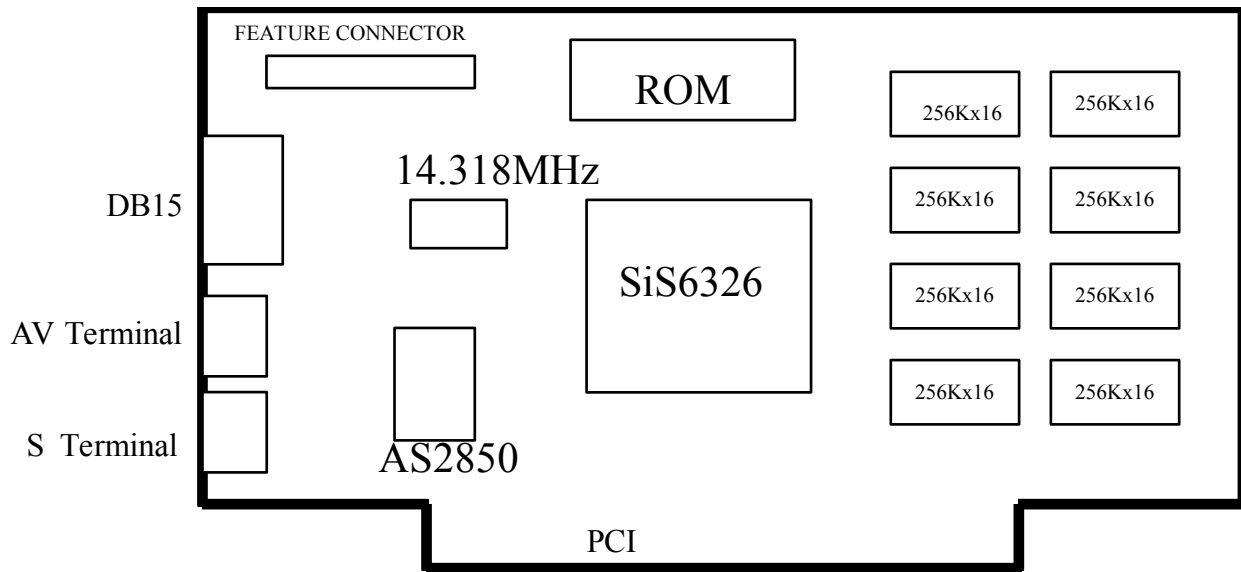

Jumper Setting

JP1 Open: NTSC
Short: PAL

JP2 Open: Disable INTA
Short: Enable INTA

JP3, JP4 (0: Open, 1: Short)

0	0	SGRAM (not support in this board)
0	1	2-cycle EDO
1	0	1-cycle EDO
1	1	FP DRAM

2. Mode Tables

2.1 Standard VGA Modes

MODE	TYPE	DISPLAY SIZE	COLORS SHADES	ALPHA FORMAT	BUFFER START	BOX SIZE	MAX. PAGES
0	A/N	320x200	16	40x25	B800	8x8	8
0*	A/N	320x350	16	40x25	B800	8x14	8
0+	A/N	360x400	16	40x25	B800	9x16	8
1	A/N	320x200	16	40x25	B800	8x8	8
1*	A/N	320x350	16	40x25	B800	8x14	8
1+	A/N	360x400	16	40x25	B800	9x16	8
2	A/N	640x200	16	80x25	B800	8x8	8
2*	A/N	640x350	16	80x25	B800	8x14	8
2+	A/N	720x400	16	80x25	B800	9x16	8
3	A/N	640x200	16	80x25	B800	8x8	8
3*	A/N	640x350	16	80x25	B800	8x14	8
3+	A/N	720x400	16	80x25	B800	9x16	8
4	APA	320x200	4	40x25	B800	8x8	1
5	APA	320x200	4	40x25	B800	8x8	1
6	APA	640x200	2	80x25	B800	8x8	1
7	A/N	720x350	4	80x25	B000	9x14	8
7+	A/N	720x400	4	80x25	B000	9x16	8
0D	APA	320x200	16	40x25	A000	8x8	8
0E	APA	640x200	16	80x25	A000	8x8	4
0F	APA	640x350	2	80x25	B000	8x14	2
10	APA	640x350	16	80x25	A000	8x14	2
11	APA	640x480	2	80x30	A000	8x16	1
12	APA	640x480	16	80x30	A000	8x16	1
13	APA	320x200	256	40x25	A000	8x8	1

NOTE: 1. A/N: Alpha/Numeric
2. APA: All Point Addressable (Graphics)

MODE	DISPLAY SIZE	COLORS SHADES	FRAME RATE.	H-SYNC.	VIDEO FREQ.
0	320x200	16	70	31.5 K	25.1 M
0*	320x350	16	70	31.5 K	25.1 M
0+	360x400	16	70	31.5 K	28.3 M
1	320x200	16	70	31.5 K	25.1 M
1*	320x350	16	70	31.5 K	25.1 M
1+	360x400	16	70	31.5 K	28.3 M
2	640x200	16	70	31.5 K	25.1 M
2*	640x350	16	70	31.5 K	25.1 M
2+	720x400	16	70	31.5 K	28.3 M
3	640x200	16	70	31.5 K	25.1 M
3*	640x350	16	70	31.5 K	25.1 M
3+	720x400	16	70	31.5 K	28.3 M
4	320x200	4	70	31.5 K	25.1 M
5	320x200	4	70	31.5 K	25.1 M
6	640x200	2	70	31.5 K	25.1 M
7*	720x350	4	70	31.5 K	28.3 M
7+	720x400	4	70	31.5 K	28.3 M
0D	320x200	16	70	31.5 K	25.1 M
0E	640x200	16	70	31.5 K	25.1 M
0F	640x350	2	70	31.5 K	25.1 M
10	640x350	16	70	31.5 K	25.1 M
11	640x480	2	60	31.5 K	25.1 M
12	640x480	16	60	31.5 K	25.1 M
13	320x200	256	70	31.5 K	25.1 M

NOTE: i - interlaced mode
n - noninterlaced mode

2.2 Enhanced Video Modes

MODE	TYPE	DISPLAY SIZE	COLORS SHADES	ALPHA FORMAT	BUFFER START	BOX SIZE	MAX. PAGES
22	A/N	1056x352	16	132x44	B800	8x8	2
23	A/N	1056x350	16	132x25	B800	8x14	4
24	A/N	1056x364	16	132x28	B800	8x13	4
25	APA	640x480	16	80x60	A000	8x8	1
26	A/N	720x480	16	80x60	B800	9x8	3
29	APA	800x600	16	100x37	A000	8x16	1
2A	A/N	800x600	16	100x40	B800	8x15	4
2D	APA	640x350	256	80x25	A000	8x14	1
2E	APA	640x480	256	80x30	A000	8x16	1
2F	APA	640x400	256	80x25	A000	8x16	1
30	APA	800x600	256	100x37	A000	8x16	1
37	APA	1024x768	16	128x48	A000	8x16	1
38	APA	1024x768	256	128x48	A000	8x16	1
39	APA	1280x1024	16	160x64	A000	8x16	1
3A	APA	1280x1024	256	160x64	A000	8x16	1
3B	APA	1600x1200	16	200x75	A000	8x16	1
3C	APA	1600x1200	256	200x75	A000	8x16	1
40	APA	320x200	32K	40x25	A000	8x8	1
41	APA	320x200	64K	40x25	A000	8x8	1
42	APA	320x200	16.8M	40x25	A000	8x8	1
43	APA	640x480	32K	80x30	A000	8x16	1
44	APA	640x480	64K	80x30	A000	8x16	1
45	APA	640x480	16.8M	80x30	A000	8x16	1
46	APA	800x600	32K	100x37	A000	8x16	1
47	APA	800x600	64K	100x37	A000	8x16	1
48	APA	800x600	16.8M	100x37	A000	8x16	1
49	APA	1024x768	32K	128x48	A000	8x16	1
4A	APA	1024x768	64K	128x48	A000	8x16	1
4B	APA	1024x768	16.8M	128x48	A000	8x16	1
4C	APA	1280x1024	32K	160x64	A000	8x16	1
4D	APA	1280x1024	64K	160x64	A000	8x16	1

NOTE: 1. A/N: Alpha/Numeric
2. APA: All Point Addressable (Graphics)

MODE	DISPLAY SIZE	COLORS SHADES	FRAME RATE.	H-SYNC.	VIDEO FREQ.
22	1056x352	16	70	30.5 K	40.0 M
23	1056x350	16	70	30.5 K	40.0 M
24	1056x364	16	70	30.5 K	40.0 M
25	640x480	16	60	31.5 K	25.1 M
26	720x480	16	60	31.5 K	25.1 M
29	800x600	16	56	35.1 K	30.0 M
29*	800x600	16	60	37.9 K	40.0 M
29+	800x600	16	72	48.0 K	50.0 M
29#	800x600	16	75	46.8 K	50.0 M
29###	800x600	16	85	53.7 K	56.3 M
2A	800x600	16	56	35.1 K	36.0 M
2D	640x350	256	70	31.5 K	25.1 M
2E	640x480	256	60	31.5 K	25.1 M
2E*	640x480	256	72	37.9 K	31.5 M
2E+	640x480	256	75	37.5 K	31.5 M
2E++	640x480	256	85	43.4 K	36.0 M
2F	640x400	256	70	31.5 K	25.1 M
30	800x600	256	56	35.1 K	36.0 M
30*	800x600	256	60	37.9 K	40.0 M
30+	800x600	256	72	48.0 K	50.0 M
30#	800x600	256	75	46.8 K	50.0 M
30###	800x600	256	85	53.7 K	56.3 M
37i	1024x768	16	87	35.5 K	44.9 M
37n	1024x768	16	60	48.4 K	65.0 M
37n+	1024x768	16	70	56.5 K	75.0 M
37n#	1024x768	16	75	60.2 K	80.0 M
37n###	1024x768	16	85	68.7 K	94.5 M
38i	1024x768	256	87	35.5 K	44.9 M
38n	1024x768	256	60	48.4 K	65.0 M
38n+	1024x768	256	70	56.5 K	75.0 M
38n#	1024x768	256	75	60.2 K	80.0 M
38n###	1024x768	256	85	68.7 K	94.5 M
39I	1280x1024	16	87	48.8 K	80.0 M
39n	1280x1024	16	60	65.0 K	110.0 M
39n+	1280x1024	16	75	80.0 K	135.0 M
3Ai	1280x1024	256	87	48.8 K	80.0 M
3An	1280x1024	256	60	65.0 K	110.0 M
3An+	1280x1024	256	75	80.0 K	135.0 M

3Bi	1600x1200	16	87	75.6 K	135.0 M
3B	1600x1200	16	60	75.6 K	162.0 M
3B*	1600x1200	16	65	75.6 K	175.5 M
3Ci	1600x1200	256	87	75.6 K	135.0 M
3C	1600x1200	256	60	75.6 K	162.0 M
3C*	1600x1200	256	65	75.6 K	175.5 M
40	320x200	32K	70	31.5 K	25.1 M
41	320x200	64K	70	31.5 K	25.1 M
42	320x200	16.8M	70	31.5 K	25.1 M
43	640x480	32K	60	31.5 K	25.1 M
43*	640x480	32K	72	37.9 K	31.5 M
43+	640x480	32K	75	37.5 K	31.5 M
43++	640x480	32K	85	43.4 K	36.0 M
44	640x480	64K	60	31.5 K	25.1 M
44*	640x480	64K	72	37.9 K	31.5 M
44+	640x480	64K	75	37.5 K	31.5 M
44++	640x480	64K	85	43.4 K	36.0 M
45	640x480	16.8M	60	31.5 K	25.1 M
45*	640x480	16.8M	72	37.9 K	31.5 M
45+	640x480	16.8M	75	37.5 K	31.5 M
45++	640x480	16.8M	85	43.4 K	36.0 M
46	800x600	32K	56	35.1 K	36.0 M
46*	800x600	32K	60	37.9 K	40.0 M
46+	800x600	32K	72	48.0 K	50.0 M
46#	800x600	32K	75	46.8 K	50.0 M
46##	800x600	32K	85	53.7 K	56.3 M
47	800x600	64K	56	35.1 K	36.0 M
47*	800x600	64K	60	37.9 K	40.0 M
47+	800x600	64K	72	48.0 K	50.0 M
47#	800x600	64K	75	46.8 K	50.0 M
47##	800x600	64K	85	53.7 K	56.3 M
48	800x600	16.8M	56	35.1 K	36.0 M
48*	800x600	16.8M	60	37.9 K	40.0 M
48+	800x600	16.8M	72	48.0 K	50.0 M
48#	800x600	16.8M	75	46.8 K	50.0 M
48##	800x600	16.8M	85	53.7 K	56.3 M

49i	1024x768	32K	87	35.5 K	44.9 M
49n	1024x768	32K	60	48.4 K	65.0 M
49n+	1024x768	32K	70	56.5 K	75.0 M
49n#	1024x768	32K	75	60.2 K	80.0 M
49n##	1024x768	32K	85	68.7 K	94.5 M
4Ai	1024x768	64K	87	35.5 K	44.9 M
4An	1024x768	64K	60	48.4 K	65.0 M
4An+	1024x768	64K	70	56.5 K	75.0 M
4An#	1024x768	64K	75	60.2 K	80.0 M
4An##	1024x768	64K	85	68.7 K	94.5 M
4Bi	1024x768	16.8M	87	35.5 K	44.9 M
4Bn	1024x768	16.8M	60	48.4 K	65.0 M
4Bn+	1024x768	16.8M	70	56.5 K	75.0 M
4Bn#	1024x768	16.8M	75	60.2 K	80.0 M
4Bn##	1024x768	16.8M	85	68.7 K	94.5 M
4Ci	1280x1024	32K	89	48.8 K	80.0 M
4Di	1280x1024	64K	89	48.8 K	80.0 M

NOTE: i - interlaced mode
n - noninterlaced mode

- For the limitation of memory bandwidth in 1MB DRAM configuration, the following video modes is not supported in 1MB configuration: modes 45*, 45+, 46+, 46#, 47+, and 47#.

2.3 Low Resolution Modes (Hidden)

MODE	TYPE	DISPLAY SIZE	COLORS SHADES	ALPHA FORMAT	BUFFER START	BOX SIZE	MAX. PAGES
50	APA	320x240	256	40x30	A000	8x8	1
53	APA	320x240	32K	40x30	A000	8x8	1
56	APA	320x240	64K	40x30	A000	8x8	1
51	APA	400x300	256	50x38	A000	8x8	1
54	APA	400x300	32K	50x38	A000	8x8	1
57	APA	400x300	64K	50x38	A000	8x8	1
52	APA	512x384	256	64x48	A000	8x8	1
55	APA	512x384	32K	64x48	A000	8x8	1
58	APA	512x384	64K	64x48	A000	8x8	1

NOTE: 1. A/N: Alpha/Numeric
2. APA: All Point Addressable (Graphics)

3. Drivers Overview

To make use of the advance features of SiS6326, extended graphics and text modes are supported by software application drivers developed by SiS. The following applications are currently supported:

- MicroSoft Windows 95
- MicroSoft Windows NT Ver. 3.5 & 3.51 & 4.0
- MicroSoft Windows 3.1
- OS/2 Presentation Manager 2.1 & 3.0
- 3D Studio Ver. 3.0
- AutoCAD/386 Release 11, 12
- Auto Shade/386 Ver. 2.0

4. Windows 95

4.1 Version Note

The following description apply to "SiS6326 Driver Release V0.90" and maybe later release version but not guaranteed.

4.2 Driver Files

The enclosed SiS6326 Windows 95 driver contains three program groups :

- display drivers (including 2D, direct draw, direct 3D, and TV-OUT support)
- display utilities (monitor's center screen support, MMPlay)
- MPEG2 video play back driver and utility

All the 16-color, 256-color, 32K/64K-color, and 16M-color drivers are available.

4.3 Display Driver

4.3.1 Installation

1. Boot up Windows 95.
2. In Windows 95 "Booted" Screen, select "My Computer" icon.
3. In "My computer" Screen, select "Control Panel" icon.
4. In "Control Panel" Screen, select "Display" icon.
5. In "Display Properties" Screen, select "Settings" item.
6. In refreshed "Display Properties" Screen, select "Change Display_Type" item.
7. In "Change Display Type" Screen, select "Adapter Type ==> Change" item.
8. In "Select Device" Screen, select "Have Disk..." item.
9. In "Install From Disk" Screen, select your driver source.
e.g. A:\WIN9510.
In new "Select Device" Screen, "SiS6326" would appear and select "OK".
Then Windows 95 would perform driver installation.
11. After completing installation, Windows 95 would go back to "Change Display Type" Screen, select "Close" item.
12. Windows 95 would go back to "Display Properties" Screen, select "Close" or "Apply" item.
13. In "System Settings Change" Screen, select "Yes" item to restart your computer.

-
-
14. After restarting, Windows 95 will run on 640x480x256 color, 60NI. And there are three additional items, "Display Modes" and "SiS TV-OUT" and "SiS Gamma Correction", may be added depends on the mode setting.

For "Display Modes" item, it would appear on the following states:

- Not in 640x480 modes for NTSC or not in 800x600 modes for PAL
- In 640x480 modes for NTSC or in 800x600 modes for PAL but TV-OUT is turned off

For "SiS TV-OUT" item, it would always appear.

For "SiS Gamma Correction" item, it would appear on 16-bit color (64K-color) and 24-bit color (true color). i.e. In 16-color and 8-bit color (256-color) modes, gamma correction function is not support.

4.3.2 Using "Display Modes"

1. Go to "Display Properties" Screen and you will find that "Display Modes" item had been added.
2. First select "Display Modes" item and you may select desired resolution by changing "Desktop area" pointer, desired color by changing "Color palette" value, desired font size by changing "Font size", and desired refresh rate by changing "Refresh rate".
3. After completing selection, select "OK" or "Apply" to complete the whole installation.
4. In "SiS6326 Settings" Screen, select "OK".
5. Two cases happen :
 - a). You did not change "color" and/or "font size".
 1. "SiS6326 Settings" Screen appears again,
 2. Select "Yes" and you may work on your selected mode now.
 - b). You changed "color" and/or "font size".
 1. System will reboot.
 2. You may work on your selected mode now.

4.3.3 Using "SiS TV-OUT"

If there are S-connector or composite connector in your adapter and you had connected your TV to one of this connector (S-connector would get more better quality) and you had turned TV on and you are in one of 640x480x60Hz modes for NTSC and 800x600x56Hz modes for PAL. Then,

1. Go to "Display Properties" Screen and you will find that "SiS TV-OUT" item had been added.
2. First select "SiS TV-OUT" item and you may
 - Use "Color Calibration Tuning" to tune your color TV to get color if it appears black/white.
 - For NTSC, use "NTSC" to select "640x480 60Hz" to get full TV display but some information would be invisible. Or select "560x420 60Hz" to get a small display screen on your TV.
 - For PAL, use "PAL" to select "800x600 50Hz" to get full TV display but some information would be invisible. Or select "720x540 50Hz" to get a small display screen on your TV.
 - Use "Screen Position" to adjust your TV display position.
 - Use "AntiFlicker Mode" to adjust the anti-flicker effect.
 - Use "Y Filter" to turn Y-filter on (image would be softer) or off (image would be sharper).
 - Use "TV-Mode" to turn TV output on or off.

-
- Note1: SiS6326 only supports TV-OUT function in the following modes:
 - For NTSC, 640x480x60Hz and 640x400x60Hz (hidden)
 - For PAL, 800x600x60Hz and 640x480x50Hz (hidden)
 - Low resolution modes but they are hidden and used by application programs and cannot be select for end user
 - Note2: If TV output is turned on, the display frame rate would be forced to 60Hz. Only when you turn off TV output and close "Display Properties" then enter "Display Properties" again, the "Display Modes" would appear and let you set other frame rates.
3. After completing selection, select "OK" or "Apply" to complete the whole setting.
 4. Two cases happen :
 - If you did not change "NTSC" selection, you may continue your job.
 - If you change "NTSC" selection, program would refresh the screen and ask if you want to keep it. Just click "Yes" if you want to keep it. Or click "No" if you don't want to change.

4.3.4 Using "SiS Gamma Correction"

If you are in TV-OUT enable modes and in 16-bit color (64K-color) or 24-bit color (true color) modes, you may use "SiS Gamma Correction" to adjust your TV display quality to your favorite style.

1. Go to "Display Properties" Screen and you will find that "SiS Gamma Correction" item had been added.
2. First select "SiS Gamma Correction" item and you may
 - Use "Setting Gamma" to tune your color TV's color style.
 - Use "Default" to return to the original program default setting.
 - Use "Brightness" to turn your TV to brighter or darker.
3. After completing selection, select "OK" or "Apply" to complete the whole setting.

4.4 Display Utilities

4.4.1 Installation

1. From "Start Menu", select "Run" item.
2. In "Run" Screen, select your source execution file.
e.g. A:\SETUP (in Win95 driver disk #1)
3. In SiS6326 utility setup, SiS uses almost industry standard setup kit "Install Shield" to provide very detail and very friendly setup procedures. Therefore if you are familiar with computer and would like to make some changes of the option items, you may read the instructions and change them. If you are not familiar with computer and don't want to change anything, then just click "Yes", "OK", or "Next" to finish the installation.
4. A "SiS Multimedia Vx.xx" program group would be created and shown on screen.
5. In the "SiS Multimedia Vx.xx" program group, there would be three icons:
 - (1) SiS Multimedia Package: To create a small "SiS Multimedia" icon on the corner of the screen.
 - (2) SiS MMPlayer: To create a "SiS MMPlayer" VCP-like icon on the screen.
(Do not use this. It's wrong programming.)

-
- (3) Center Screen: An utility to adjust the position of display on the screen.

4.5 MPEG2 Video Playback Utility

4.5.1 Installation











1. From "Start Menu", select "Run" item.
2. In "Run" Screen, select your source execution file.
e.g. A:\SETUP (in Win95 driver disk #4 "SiS6326 MPEG2 Video Playback Utility")
3. In SiS6326 utility setup, SiS uses almost industry standard setup kit "Install Shield" to provide very detail and very friendly setup procedures. Therefore if you are familiar with computer and would like to make some changes of the option items, you may read the instructions and change them. If you are not familiar with computer and don't want to change anything, then just click "Yes", "OK", or "Next" to finish the installation.
4. A "SiS MPEGII " program group would be created and shown on screen.
5. In the "SiS MPEGII" program group, there would be one icon:
 - (1) SiS MMPlayer: To create a "SiS MMPlayer" VCP-like icon on the screen to play MPEG2 video clippers.





4.5.2 Operation

Note: Uses "SiS MMPlayer" to play MPEG2 video clippers is just a temporary solution to show the SiS6326 MPEG2 video decoder capability. The goal of SiS is to provide a complete DVD solution in the final. Therefore the operations of "SiS MMPlayer" are not all well implemented. Please wait for further information from your supplier or SiS.

Note: Since currently "SiS MMPlayer" does not implement audio, therefore please turn off "rate control" in the configuration menu (click "Open File & Type Control" bottom and select "configure" item) to avoid unexpected error.

MMPLAY.EXE Button Description

	: Power On/Off
	: Open File & Type Control
	: Minimize This Application
	: Eject CD Title (not implemented yet.)
	: Fast Backward (not implemented yet)
	: Fast Forward (not implemented yet)
	: Mark in (not implemented yet)
	: Mark out (not implemented yet)
	: Pause
	: Play

- : Stop
- : End (not implemented yet)
- : Begin (not implemented yet)
- : Volume increase (not implemented yet.)
- : Volume decrease (not implemented yet.)

5. Windows 3.1

5.1 Version Notes

The following description apply to "SiS6326 Driver Release V0.90" and maybe later release version but not guaranteed.

5.2 Driver Files

1. The enclosed SiS 5596 Windows 3.1 driver contains the following files (in compressed format) :

DISK1.ID	Diskette #1 ID
Setup Programs	A group of programs used to setup drivers.
WIN31.1	Win31 driver files #1
DISK2.ID	Diskette #2 ID
WIN31.2	Win31 driver files #2

5.3 Installation

The installation procedure use almost industry standard "InstallShield Wizard" to guide user to complete the installation. Therefore to install the driver and utilities to where they should resides, please just follow the following procedures and the instructions on the screen.

1. Boot up Windows using standard VGA mode.
2. In Windows Program Manager Screen, choose "File" item.
3. In "File Item List", choose "Run" item.
4. In "Run" Screen, select your driver source.
e.g. A:\setup
5. Follows the directions appeared on the screen to complete the installation.
If you are not a computer expert, just use the default setting and click "Next" or "OK" to finish the installation.
6. After installation complete, a "SiS Multimedia Vx.xx" program group would be created and shown on screen.
7. In the "SiS Multimedia Vx.xx" program group, there would be six icons:
 - (1) SiS Multimedia Manager: To create a small "SiS Multimedia" icon on the corner of the screen.
 - (2) Center Screen: An utility to adjust the position of display on the screen.
 - (3) SVGA Setup: SiS VGA graphics configuration system allows you to set resolution, colors, frame rate, font, power saver, zooming, ...etc.
 - (4) Gamma Correction: Dialog for you to adjust the screen color and brightness to your preference.
 - (5) SiS MMPlayer: To create a "SiS MMPlayer" VCP-like icon on the screen.
 - (6) unInstall: To uninstall all the installed driver files and utilities.

5.4 SVGA Setup

5.4.1 Graphics Setup

1. In "SiS Multimedia Vx.xx" program group, choose "SVGA Setup" icon to enter "SiS VGA Configuration System" screen.
2. In "SiS VGA Configuration System" Screen, choose which options you would like to use.
3. After completing your selections, choose "OK" to make all your selections effective.
4. Choose "Restart Winodws" to re-boot Windows using new settings.
Or, choose "Continue" to continue your current Windows processes.
(But when you re-boot Windows, the new settings would take effect.)

5.4.2 Power Saving Setup

1. In "SiS VGA Configuration System" screen, choose "power saver" item to enter "Power Saver" screen.
2. In "Power Saver" Screen, choose which options you would like to use.
3. After completing the selections, choose "OK" to make all your selections effective.
4. After complete setup, the power_saver would take effect as you request when time up and you may continue your normal process.

5.4.3 Zoom_Key Setup

0. In "SiS VGA Configuration System" screen, choose "zooming" item to define "hot keys" for zoom-in or zoom-out screen without entering setup program.
The operation principles of zoom-in and zoom-out are as follow:
 - (1) The resolution change sequence for zoom-in is
1024x768 ==> 800x600 ==> 640x480 .
 - (2) The resolution change sequence for zoom-out is
640x480 ==> 800x600 ==> 1024x768 .
 - (3) But you must first be able to zoom-in before you may zoom-out, that means you can not get a resolution larger than that you setup.To use this feature, please follow the following procedures.
 1. In "SiS VGA Configuration System" screen, choose "zooming" item to enter "Zooming Hotkey" screen.
 2. In "Zooming Hotkey" Screen, choose which "hot key" you would like to use and enable it.
 3. After completing the selections, choose "OK" to make all your selections effective.
 4. After complete setup, you may use your own defined hot key to zoom-in or zoom-out screen.

5.4.4 Notes

-
1. The power saver's timer settings would be effective even exit Windows back to DOS.

5.5 Video Operations

5.5.1 DCI Function

SiS6326 supports DCI driver for software MPEG playback and other media player programs which could take advantage of DCI.

The SiS6326 DCI driver is automatically loaded during "Windows Installation" process. Therefore it should be transparent to the end-user and any media players could take advantage of it.

5.5.2 SiS MMPlayer (SW MPEG)

To make SW MPEG playback more friendly than original SW MPEG player supplier provided, SiS provide an MMPlayer application program to provide an VCP-like (Video Cassette Player) interface.













To take advantage of the SiS MMPlayer, you must first install "SW MPEG Player". All the SiS provided is just an interface but not a SW MPEG Player at present. If the SW MPEG Player does not exist, the SiS MMPlayer will not work. (Xing or Mediamatics SW MPEG Player supported)

To use the SiS MMPlayer, you just follow the procedures below:

1. In "SiS Multimedia Vx.xx" program group, choose "SiS MMPlayer" icon and SiS MMPlayer VCP-like icon would appear.
2. Enjoy the SW MPEG playback as you like.

5.5.3 Notes on MMPlayer

Button Description

	: Power On/Off
	: Open File & Type Control
	: Minimize This Application
	: Eject CD Title(Not implemented yet.)
	: Fast Backward
	: Fast Forward
	: Mark in
	: Mark out
	: Pause
	: Play
	: Stop
	: End
	: Begin



: Volume increase (Not implemented yet.)



: Volume decrease (Not implemented yet.)

6. Windows NT 4.0

6.1 Driver Files

1. The enclosed SiS6326 Windows NT 4.0 drivers are:
SISV256.DLL
SISV.DLL
SISV.SYS
SISV6326.INF
2. All the 16-color, 256-color, 32K/64K-color, and 16M-color drivers are available.

6.2 Installation

1. Boot up Windows NT 4.0
2. In Windows NT 4.0 "Booted" Screen, select "My Computer" icon.
3. In "My computer" Screen, select "Control Panel" icon.
4. In "Control Panel" Screen, select "Display" icon.
5. In "Display Properties" Screen, select "Settings" item.
6. In refreshed "Display Properties" Screen, select "Change Display Type" item.
7. In " Display Type" Screen, select " Change" item in "Adapter Type".
8. In "Change Display" Screen, select "Have Disk..." item.
9. In "Install From Disk" Screen, select your driver source.
e.g A:\WINNT40
10. In new "Select Device" Screen, "SiS 6326" would appear and select "OK". Then NT4.0 would perform driver installation.
11. After completing installation, NT 4.0 would go back to "Change Display Type" Screen, select "Close" item.
12. NT40 would go back to "Display Properties" Screen, select "Close" or "Apply" item.
13. In "System Settings Change" Screen, select "Yes" item to restart your computer.
14. After restarting, NT4.0 will run on 640x480x256 color, 60NI.

6.3 Using "Display Modes"

1. Go to "Display Properties" Screen and you will find that "Display Modes" item had been added.
2. First select "Display Modes" item and you may select desired resolution by changing "Desktop area" pointer, desired color by changing "Color palette" value, desired font size by changing "Font size", and desired refresh rate by changing "Refresh rate".
3. After completing selection, select "OK" or "Apply" to complete the whole installation.

4. In "SiS 6326 Settings" Screen, select "OK".
5. Two cases happen :
 - a) You did not change "color" and/or "font size".
 - i. "SiS 6326 Settings" Screen appears again,
 - ii. Select "Yes" and you may work on your selected mode now.
 - b) You changed "color" and/or "font size".

System will reboot.
You may work on your selected mode now.

7. Windows NT 3.5 & 3.51

7.1 Driver Files

1. The enclosed SiS6326 Windows NT 3.5 & 3.51 drivers are:
 - SISTAG**
 - SISV.SYS**
 - SISV256.DLL**
 - SISV.DLL**
 - OEMSETUP.INF**
2. All the 16-color, 256-color, 32K/64K-color, and 16M-color drivers are available.

7.2 Installation

1. Boot up Windows NT 3.5 or 3.51.
2. Run the following procedures:
 - a) Control Panel
 - b) Display
 - c) Change Display Type
 - d) Change
 - e) Other...

Then respond to installation prompts.

8. Autodesk ADI 4.2 -Protected Mode

8.1 General Description

8.1.1 Driver Files

1. The enclosed SiS6326 ADI driver contains the following file:
RCPSIS.EXP SiS ADI Driver (for all resolutions & colors)
Note: This version of ADI driver does not support 16-color operation.
2. This driver fits for a series of Autodesk Inc. products including:
 - (1) AutoCAD/386 R11
 - (2) AutoCAD/386 R12
 - (3) AutoShade/386 V2.0
 - (4) 3D Studio V3.0
3. Their installation procedures are different from one program to the others. But the first step of installation is the same for all these programs, that is "To unpack and copy drivers to where you would like them to reside." Therefore, we will state this step below.
4. As to the real installation procedures for each program, we will give a detail description in the following paragraph.

8.1.2 Unpack & Copy

To unpack and copy drivers to where they should reside, please follow the following procedures:

1. Run "INSTDRV.EXE" where it resides.
3. In "SiS Super VGA Drivers Installation" menu, select "A. ADI 4.2" to unpack and copy drivers.
(To select, type "A".)
5. In "Unpack & Copy ADI 4.2 Drivers" screen,
key in the "drive:\directory" where these drivers would reside
(default C:\ADI42).
Program would unpack & copy all related driver files to where you assign.
6. After "unpack and copy" completed,
exit the INSTDRV.EXE program.
7. Refer to Sec. 5.1 to Sec. 5.4 for the real installation procedures for each program.

8.2 AutoCAD R11 Setup

1. The following procedures assume that
 - (1) You have complete "unpack & copy" procedure.
 - (2) Your ADI 4.2 drivers are located in C:\ADI42.
2. Add the following setting to your own batch file for AutoCAD R11 (say ACADR11.BAT) or to your "AUTOEXEC.BAT" file:
SET DSPADI=\ADI42\RCPSIS.EXP <Enter>
3. Delete the configure file ACAD.CFG resides in \ACAD directory.
4. Type
ACADR11 <Enter>
to configure your AutoCAD R11 system.
5. In "Select Display Device:" item, choose "ADI P386 V4.0/4.1 display."
6. In "Select Display Resolution" screen, choose which display driver you want to use.
7. Go through the whole instructions, and the system would start with the desired display setting.

8.3 AutoCAD R12 Setup

1. The following procedures assume that
 - (1) You have complete "unpack & copy" procedure.
 - (2) Your SiS ADI 4.2 drivers are located in C:\ADI42.
 - (3) Your AutoCAD R12 program is located in C:\ACADR12.
 - (4) Your AutoCAD R12 default drivers are located in C:\ACADR12\DRV.
 - (5) Your AutoCAD R12 configure file ACAD.CFG is located in C:\ACADR12.
2. Copy the following driver file to C:\ACADR12\DRV:
RCPSIS.EXP
.
You may complete this step by
COPY C:\ADI42\RCPSIS.EXP C:\ACADR12\DRV
.
3. Delete your original ACAD.CFG file.
You may complete this step by
DEL C:\ACADR12\ACAD.CFG
.
4. Restart your AutoCAD R12 program as usual.
5. AutoCAD R12 will ask you to complete the configuration procedures since it can't find the configure file ACAD.CFG.
6. Follow the instructions of AutoCAD R12 to proceed configuration.
7. In "Available Video Displays:" item,
choose the "SiS Super VGA ADI v4.2 Display and Rendering driver" item.
8. In "Select Display Resolution" screen,
choose which display driver you want to use.
9. Go through the whole instructions, and the system would start with the selected display setting.

8.4 AutoShade R2.0 Setup

1. The following procedures assume that
 - (1) You have complete "unpack & copy" procedure.
 - (2) Your ADI 4.2 drivers are located in C:\ADI42.
2. Add the following settings to your batch file for AutoShade R2.0 (say SHADE2.BAT) or to your "AUTOEXEC.BAT" file.
 - (a) For display driver setting,
SET DSPADI=\ADI42\RCPSIS.EXP
 - (b) For rendering driver setting,
SET RDPADI=\ADI42\RCPSIS.EXP
3. Delete the configure file SHADE.CFG.
4. Type
SHADE2 <Enter>
to re-configure the AutoShade.
5. While prompting "Select display device:",
choose "P386 AutoDesk Device Interface display driver."
6. While prompting "Select rendering display driver:",
choose "P386 AutoDesk Device Interface rendering driver."
7. Go through all the instructions,
the system would start with the desired display setting.

8.5 3D Studio Version 3.0 Setup

1. The following procedures assume that
 - (1) You have complete "unpack & copy" procedure.
 - (2) Your ADI 4.2 drivers are located in C:\ADI42.
2. Create your own **3D Studio V3.0 batch file (say 3DS3.BAT)** and add the following settings to it, or add the following settings to your "**AUTOEXEC.BAT**" file.
 - (1) **SET RCPADI=C:\ADI42\RCPSIS.EXP**
 - (2) **SET RDPADI=C:\ADI42\RCPSIS.EXP**
3. Execute the new 3DS batch file or reboot the computer using the new "**AUTOEXEC.BAT**" as to make the new settings effective.
4. Change your current working directory to \3DS3 (where your 3D Studio V3.0 usually resides).
5. Delete original configuration file "3DADI.CFG".
6. Type
3DS VIBCGF <Enter>
to configure your display environment.
7. After the "Company Register Screen" appears, press **<Enter>** to continue.
8. The "Video Environment Configuration Screen" will appear. Please follow the following procedures to configure your video display environment.
 - (1) In "Main-Display" item,
 - (a) Press **<Enter>**
The selection menu will appear.
 - (b) In selection menu, move cursor to "**RCPADI**".
Press **<Enter>**
to select.
 - (2) In "Material-Display" item,
 - (a) Press **<Enter>**
The selection menu will appear.
 - (b) In selection menu, move cursor to "**RCPADI**".
Press **<Enter>**
to select.
 - (3) In "Render-Display" item,
 - (a) Press **<Enter>**
The selection menu will appear.
 - (b) In selection menu, move cursor to "**RCPADI**" or "**RDPADI**".
Press **<Enter>**
to select.
 - (4) Complete the other selections and exit configuration.
9. After exit configure,

- 3DS will boot automatically using the environment you just select.
10. If your previous configuration is OK, 3DS will ask you to make detail configuration for SiS6326 drivers. If this didn't happen, please check your previous procedures or contact the technical support people.
11. In the detail configuration for SiS6326 drivers, just follow the instructions appear on the screen and make your own choice. If you are confused in anything, contact the technical support people for solution.
12. After detail configuration, you will enter the 3DS main display screen and you may begin your 3D Studio work in the environment you make before.
13. Once completing the detail configuration, you may enter 3D Studio in the same configuration simply by type
\3DS\3DS <Enter>
next time.
14. If you want to change your video configuration, just follow the procedures mentioned before to re-configure.

9. OS/2 V2.1

9.1 Driver Notes

1. The following description apply to "SiS6326 Driver Release V1.01" and maybe later release version but not guaranteed.

9.2 Driver Files

1. The enclosed SiS6326 OS/2 2.1 driver contains the following files:
SISINST.COMD SiS driver install program
SVGA.EXE SiS PMI Generator
S768256.DL@ SiS IBMDEV32.DLL Display Driver
OTHERS other files required during installation

9.3 Installation

Before install SiS6326 OS/2 drivers, make sure:

1. Install your OS/2 system using "**VGA display**" option (i.e. standard VGA).
2. Start your OS/2 system.

Install SiS6326 OS/2 2.1 drivers as following procedures:

1. Enter "OS/2 window" or "OS/2 full screen".
2. Change directory to which holds the SiS6326 OS/2 2.1 display drivers and type SISINST <Enter>.
For example,
A:\OS2\SBCS.21>SISINST
3. All the Driver Files will be copied to a subdirectory C:\SISDRV and the "Select Screen parameters for SiS SVGA" menu appears and all the resolution (and color) and frame rate supported would be shown on the screen.
4. Choose which one you would like to use and click "OK".
5. Then installation program would complete all installation process and create a "SiS Setup" for future change mode usage.
6. Shutdown and re-boot OS/2 to make your selection effectively.

10. OS/2 V3.0 (Warp)

10.1 Driver & OS/2 Version Notes

1. The following description apply to "SiS6326 Driver Release V0.90" and maybe later release version but not guaranteed.
2. All the OS/2 Warp Versions up to SiS6326 driver Rev. 0.90 would be installed as described in this section except for Double Bytes OS/2 Warp (i.e. Chinese, Japanese, Korea, etc.).
3. For Double Bytes OS/2 Warp installation, please refer to "Sec. 11 Double Bytes OS/2 Warp".

10.2 Driver Files

1. The enclosed SiS6326 OS/2 3.0 driver contains the following files:

SISINST.CMD	SiS driver install program
SVGA.EXE	SiS PMI Generator
S768256.DL@	SiS IBMDEV32.DLL Display Driver
OTHERS	other files required during installation

10.3 Installation

Before install SiS6326 OS/2 drivers, make sure:

1. Install your OS/2 system using "**VGA display**" option (i.e. standard VGA).
2. Start your OS/2 system.

Install SiS6326 OS/2 Warp drivers as following procedures:

1. Enter "OS/2 window" or "OS/2 full screen".
2. Change directory to which holds the SiS6326 OS/2 3.0 display drivers and type SISINST <Enter>. For example,
A:\OS2\SBCS.30>SISINST
3. All the Driver Files will be copied to a subdirectory C:\SISDRV and the "Select Screen parameters for SiS SVGA" menu appears and all the resolution (and color) and frame rate supported would be shown on the screen.
4. Choose which one you would like to use and click "OK".
5. Then installation program would complete all installation process and create a "SiS Setup" for future change mode usage.
6. Shutdown and re-boot OS/2 to make your selection effectively.

11. Double Bytes OS/2 Warp

11.1 Driver & OS/2 Version Notes

1. The following description apply to "SiS6326 Driver Release V0.90" and maybe later release version but not guaranteed.
2. The following description apply to "Double Bytes OS/2 Warp" only. (i.e. Chinese, Japanese, Korea, etc.)
3. For other versions OS/2 Warp installation, please refer to "Sec. 2 OS/2 V3.0 (Warp)".

11.2 Driver Files

1. The enclosed SiS6326 Double Byte OS/2 3.0 driver contains the following files:

SETUP.CMD	SiS driver install program
SVGA.EXE	SiS PMI Generator
S768256.DL@	SiS IBMDEV32.DLL Display Driver
OTHERS	other files required during installation

11.3 Installation

For Double Byte OS/2 Warp limitation, the installation process is a two-phase installation and can't complete the whole installation in one-time-process.

- 1st phase: copy files, modify "config.sys", create "SiS Install" icon
then shutdown and re-boot OS/2.
- 2nd phase: double clicks "SiS Install" icon to complete the installation

Before install SiS6326 OS/2 drivers, make sure:

1. Install your OS/2 system using "VGA display" option (i.e. standard VGA).
2. Start your OS/2 system.

Install SiS6326 OS/2 Warp drivers as following procedures:

1st phase:

1. Enter "OS/2 window" or "OS/2 full screen".
2. Change directory to which holds the SiS6326 OS/2 3.0 display drivers and type
SETUP <Enter>,
For example,
A:\OS2\DBCS.30>SETUP
3. All the Driver Files will be copied to a subdirectory C:\SISDRV and "SiS Install" icon would be created.
4. After completing "setup" program, shutdown and re-boot OS/2.

2nd phase:

5. After re-booting OS/2, double clicks "SiS Install" icon.
Then the "SiS Install" icon would be executed automatically and "Select Screen parameters for SiS SVGA" screen would appeared on the screen.
6. Select the desired resolution (and color) and frame rate on this screen,
then click "OK" to complete installation and "SiS Setup" icon would be created for future change modes and frame rate usage.

-
-
7. After completing installation, shutdown and re-boot OS/2 to make your selection effectively.

12. COPYRIGHT NOTICE

COPYRIGHT 1997, Silicon Integrated Systems Corp. ALL RIGHTS RESERVED.

This manual is copyrighted By Silicon Integrated Systems Corp. You may not reproduce, transmit, transcribe, store in a retrieval system, or translate into any language, in any form or by any means, electronic, mechanical, magnetic, optical, chemical, manual, or otherwise, any part of this publication without the express written permission of Silicon Integrated Systems Corp.

TRADEMARKS

SiS is a registered trademark of Silicon Integrated Systems Corp.

All brand or product names mentioned are trademarks or registered trademarks of their respective holders.

DISCLAIMER

Silicon Integrated Systems Corp. makes no representations or warranties regarding the contents of this manual. We reserve the right to revise the manual or make changes in the specifications of the product described within it at any time without notice and without obligation to notify any person of such revision or change.

The information contained in this manual is provided for general use by our customers. Our customers should be aware that the personal computer field ins the subject of many patents. Our customers should ensure that they take appropriate action so that their use of our products does not infringe upon any patents. It is the policy of Silicon Integrated Systems Corp. To respect the valid patent rights of third parties and not to infringe upon or assist others to infringe upon such rights.

RESTRICTED RIGHTS LEGEND

Use, duplication, or disclosure by the Government is subject to restrictions set forth in subparagraph (c)(1)(ii) of the Rights in Technical Data and Computer Software clause at 252.277-7013.